

NEXDOME

2.2 METER DOME

Patent No. U S9,315,983 B1

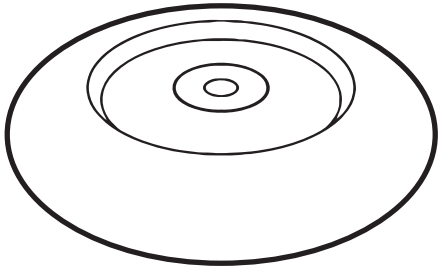

WHEELS

X4



5/16 X 5/8"

X8



5/16 X 3/4" NB

X4



5/16"

X4

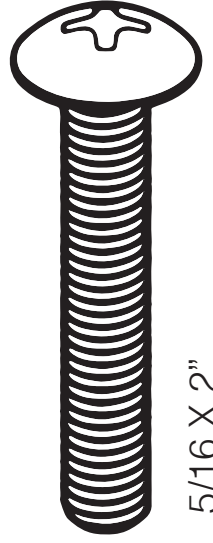

5/16 X 2"

X4



1/4 X 3/4"

X30



1/4 X 3/4" NB

X30



1/4"

X30

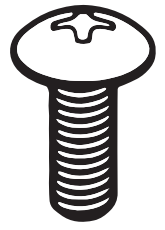

1/4 X 3/4"

X30

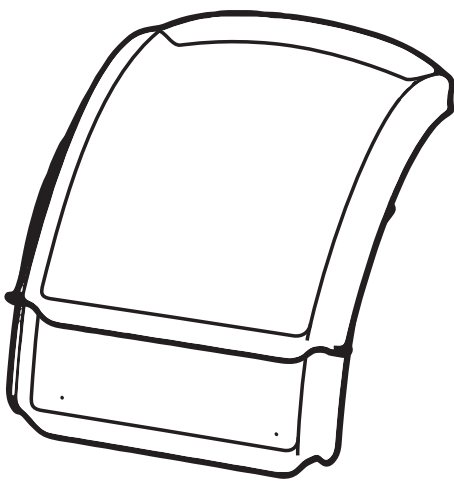

X1

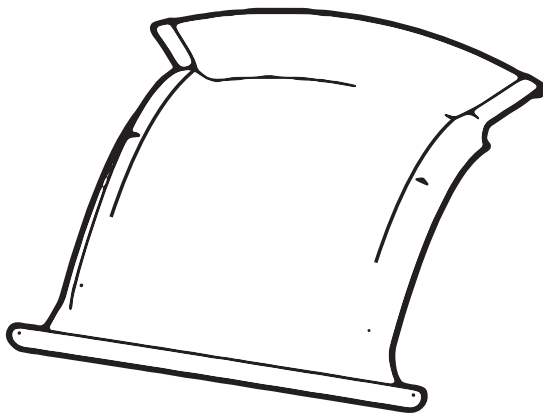

X2

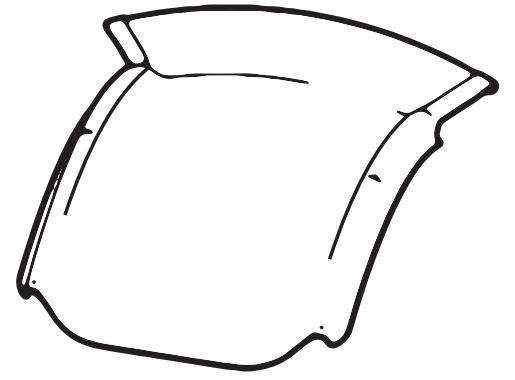

X1

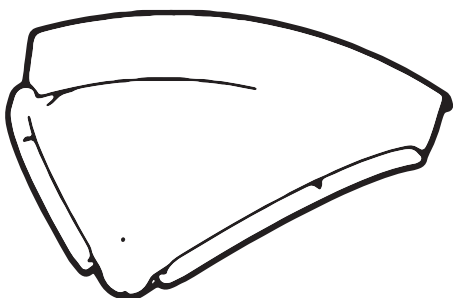

X2

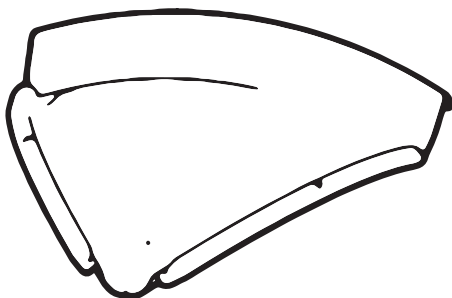

X2



X1



X1

1

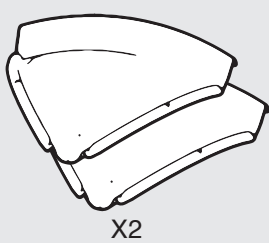
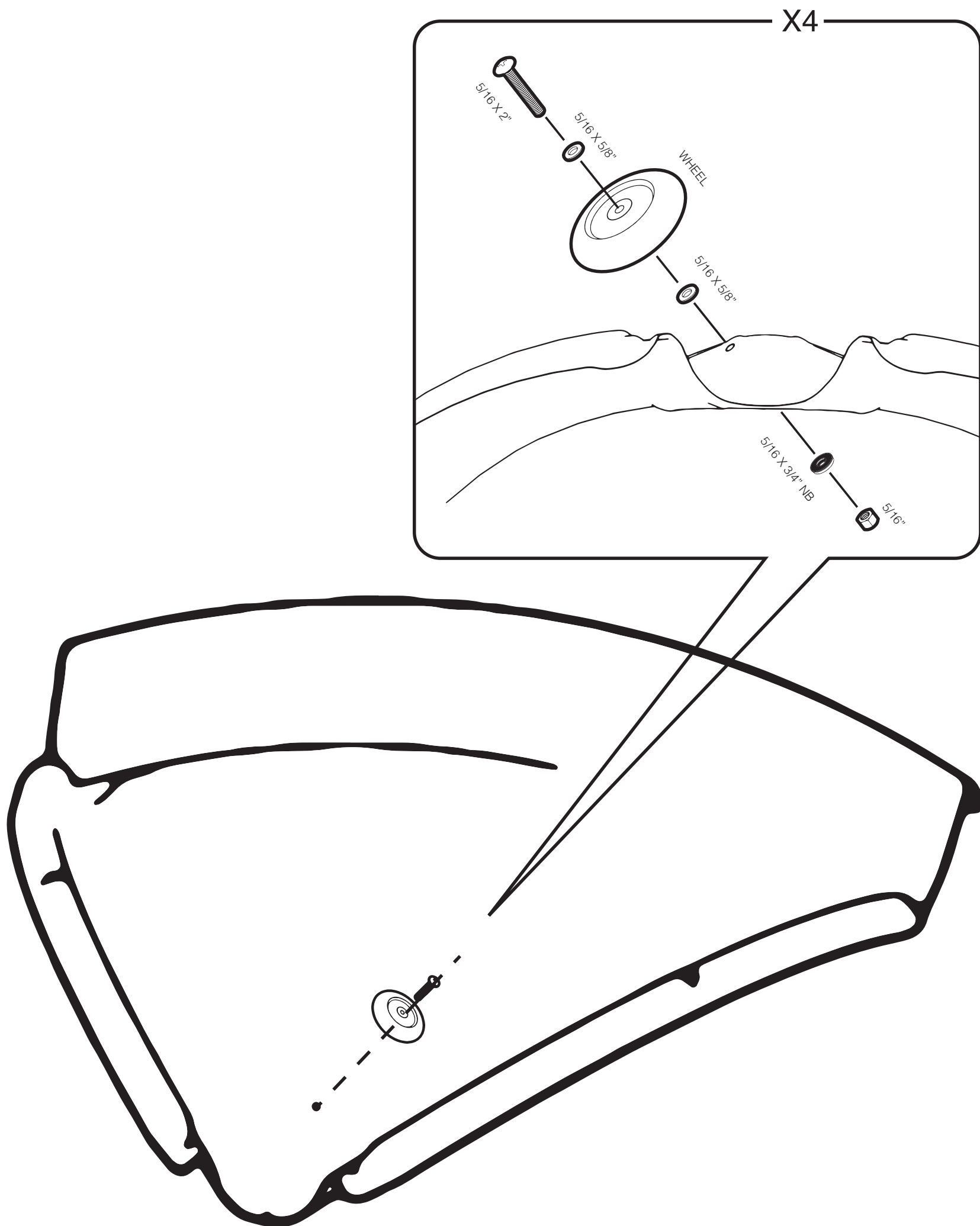

CORNER PANEL B

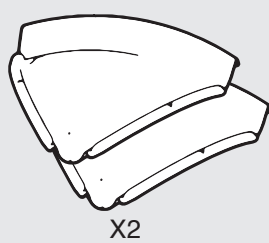

CORNER PANEL A

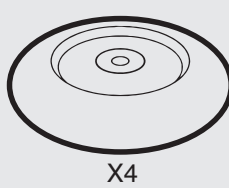

WHEELS



5/16 X 5/8"



5/16 X 3/4" NB



5/16"

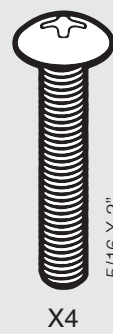

5/16 X 2"

2

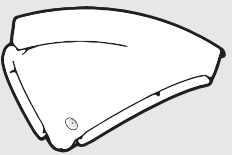
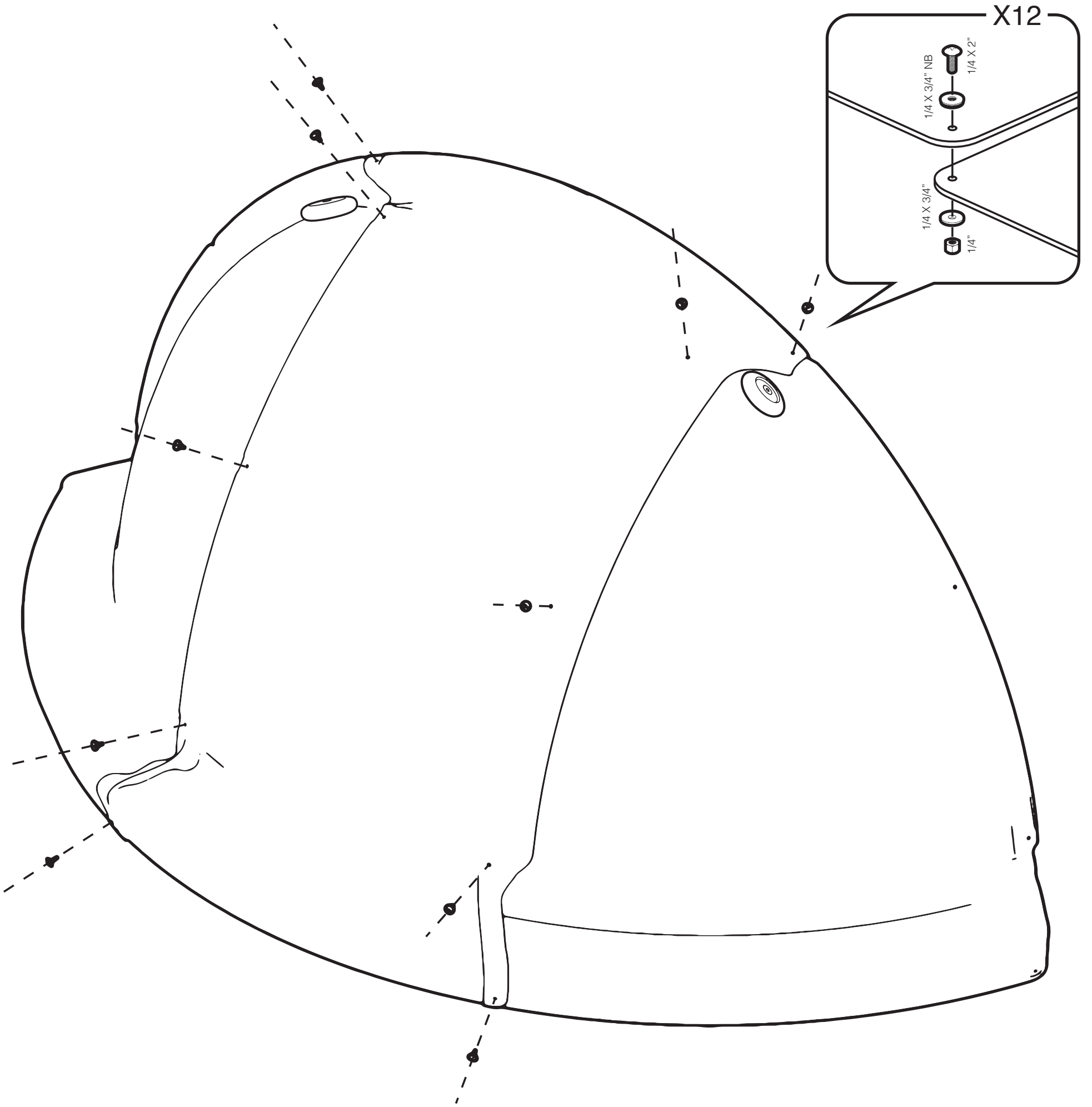

X1

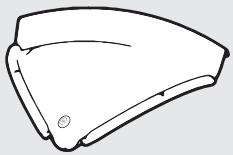

X1

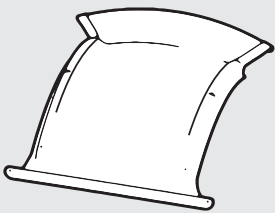

X1



X30

1/4 X 3/4"



X12

1/4 X 3/4" NB



X12

1/4"



X12

1/4 X 3/4"

3

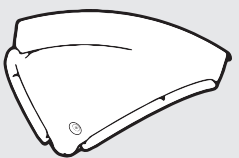
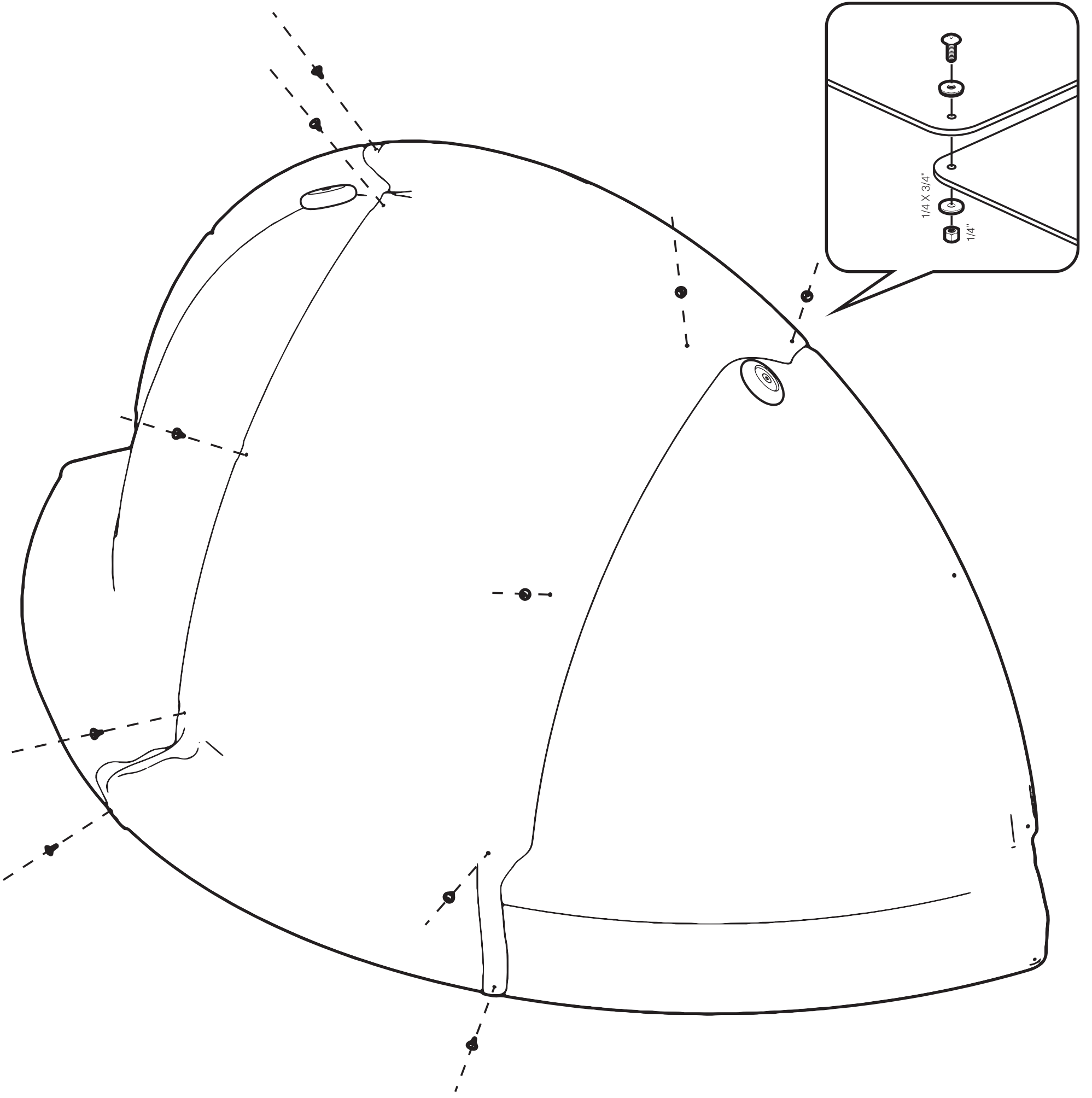

X1

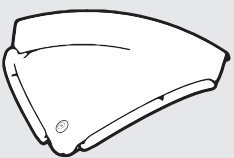

X1

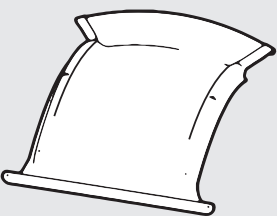

X1



X30

1/4 X 3/4"



X12

1/4 X 3/4" NB



X12

1/4"



X12

1/4 X 3/4"

4

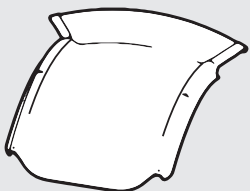
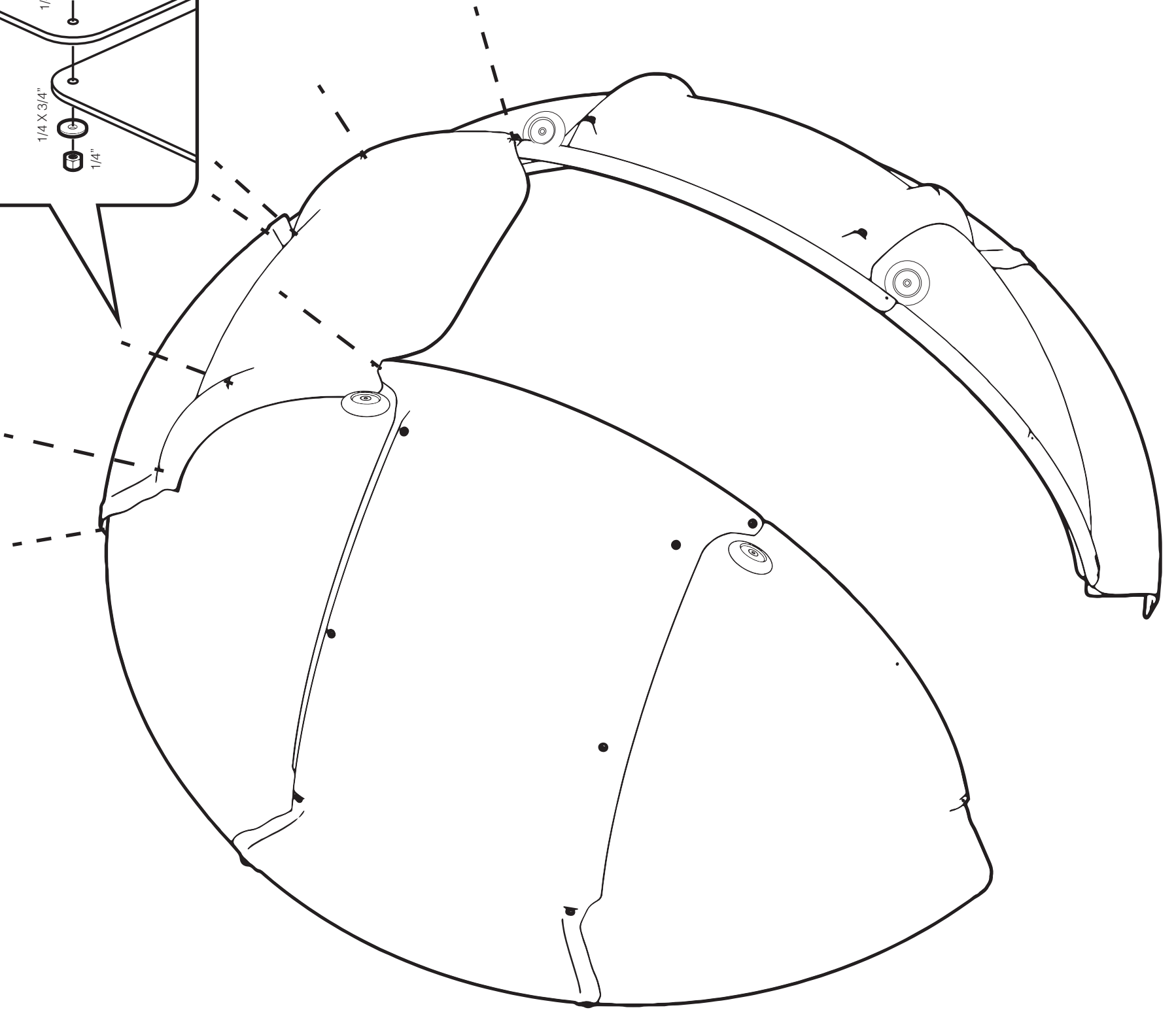
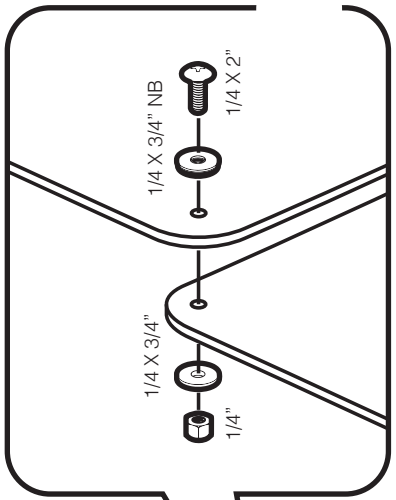
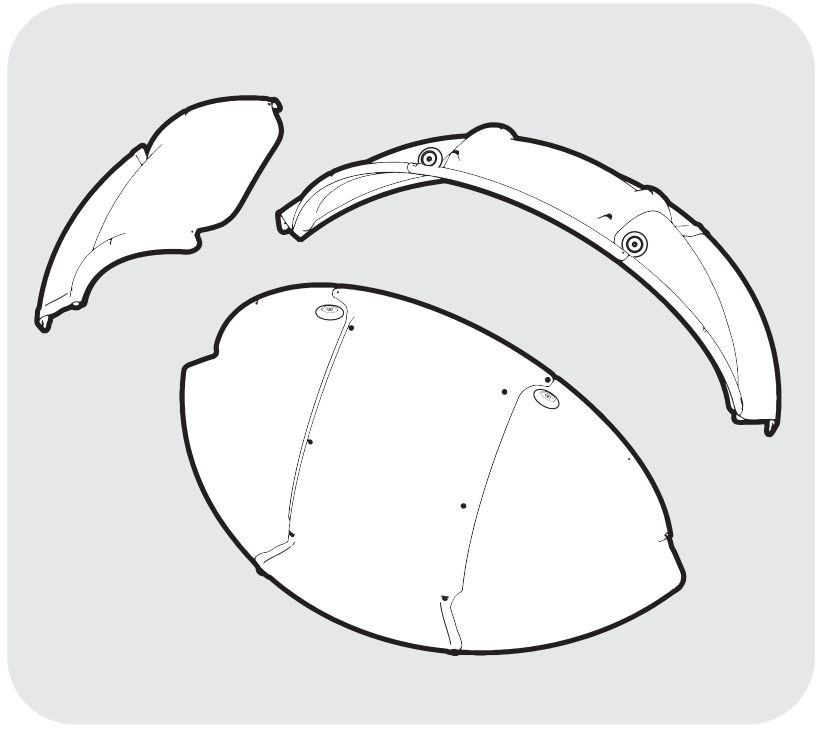

X1

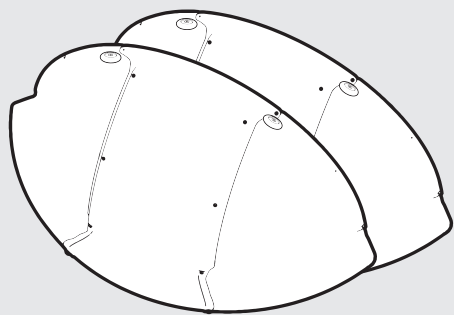

X2



X8



X8



X8



X8

1/4 X 3/4" NB

1/4"

1/4 X 3/4"

5

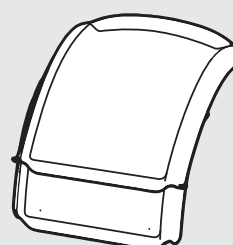
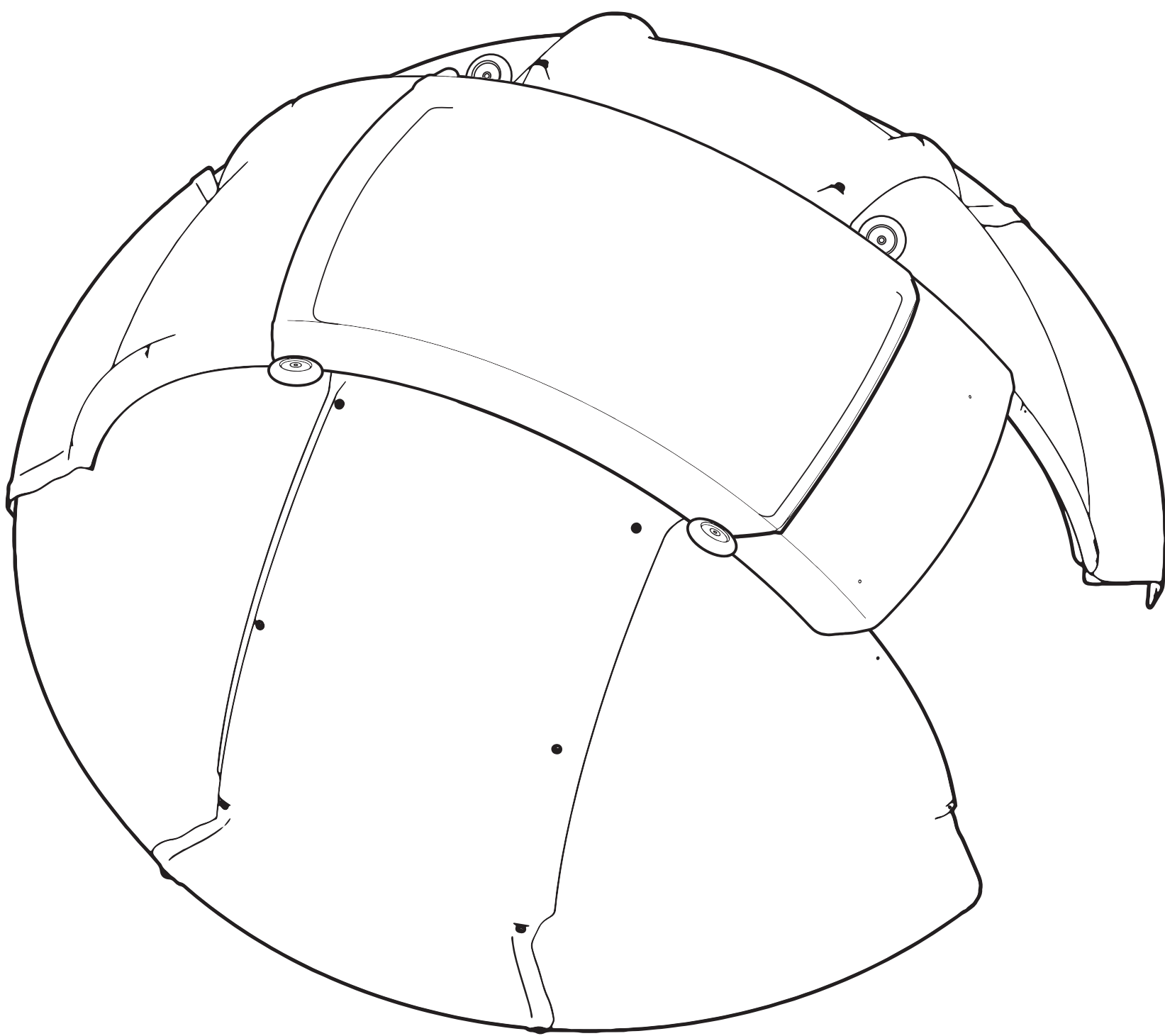
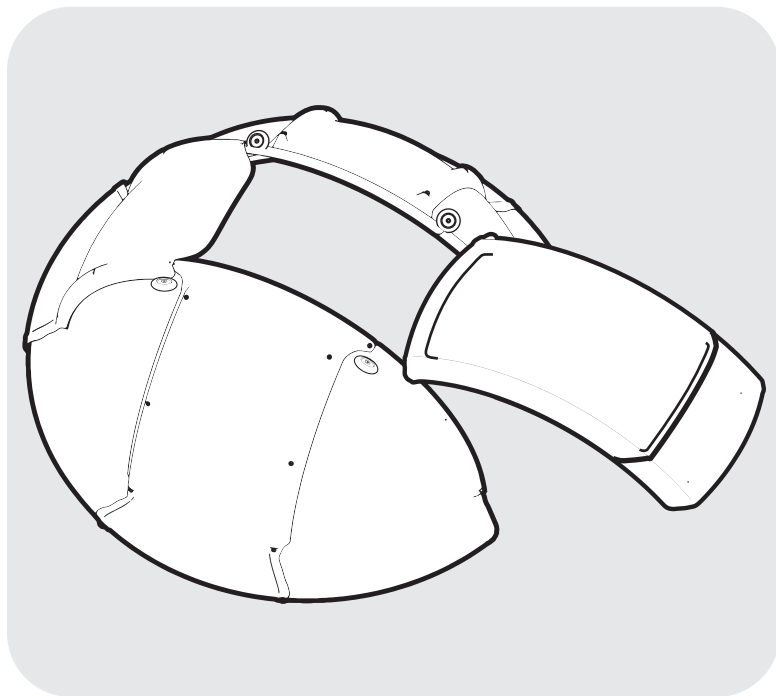

X1

6

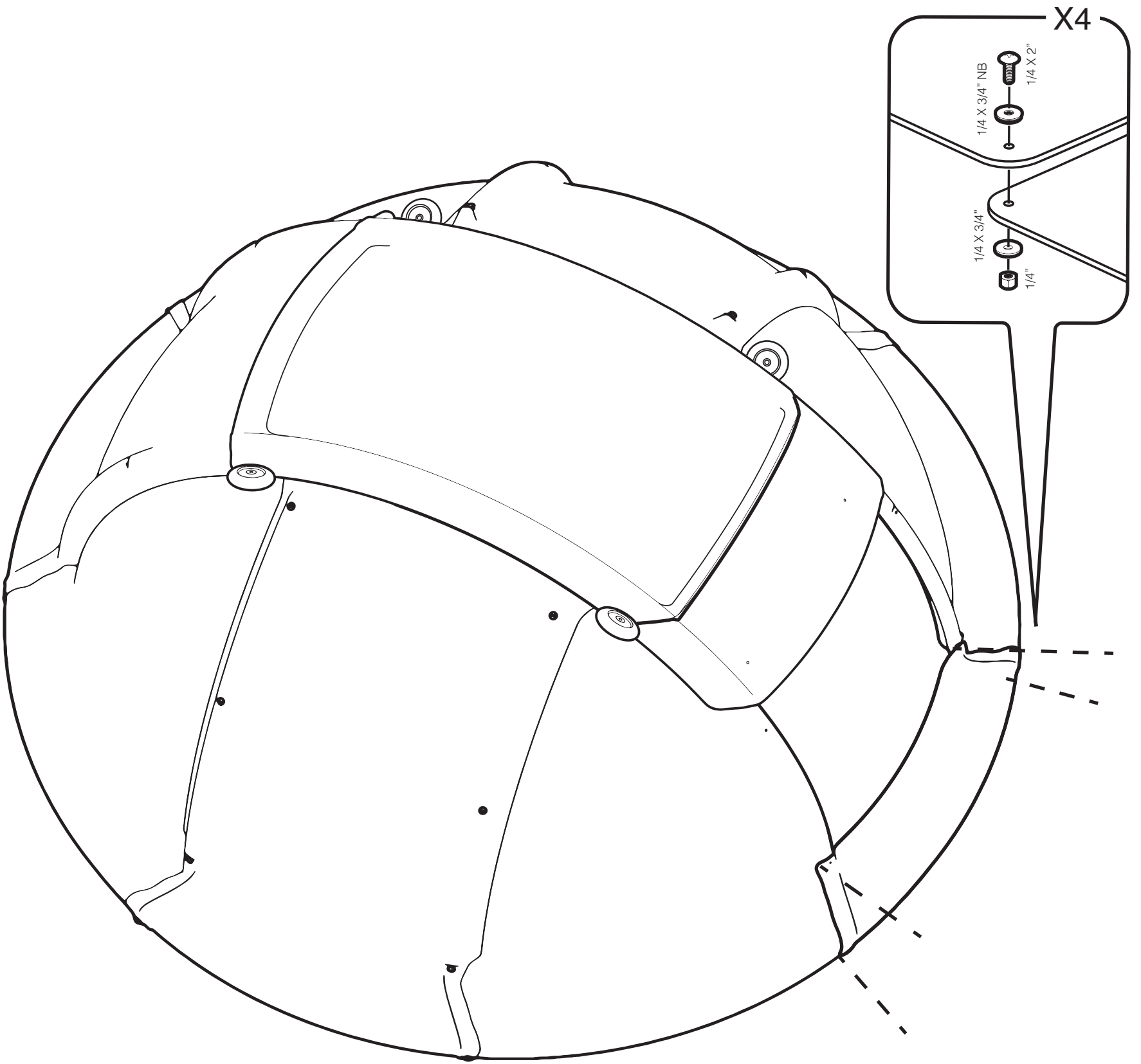
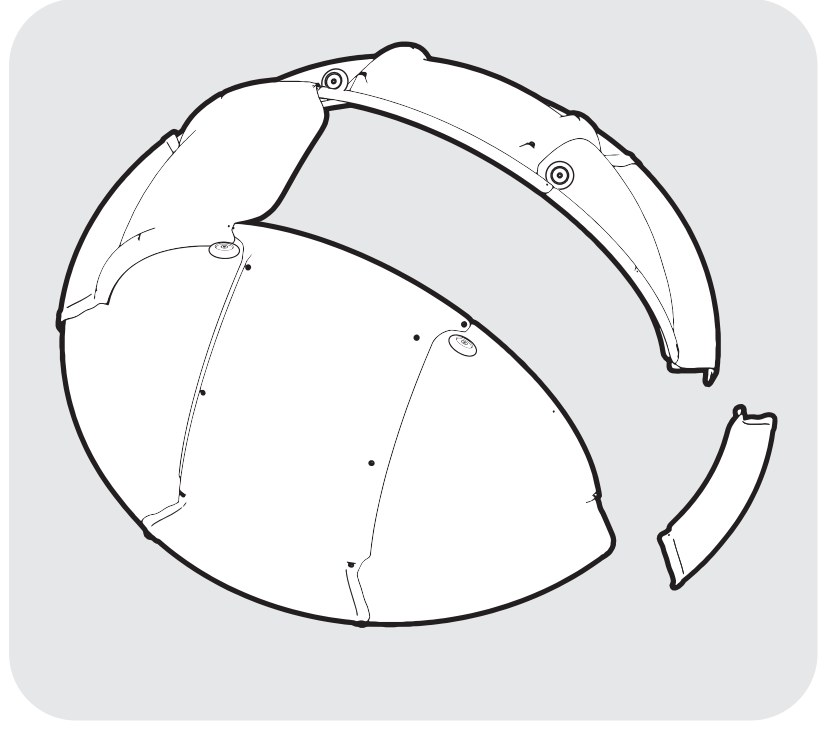

7

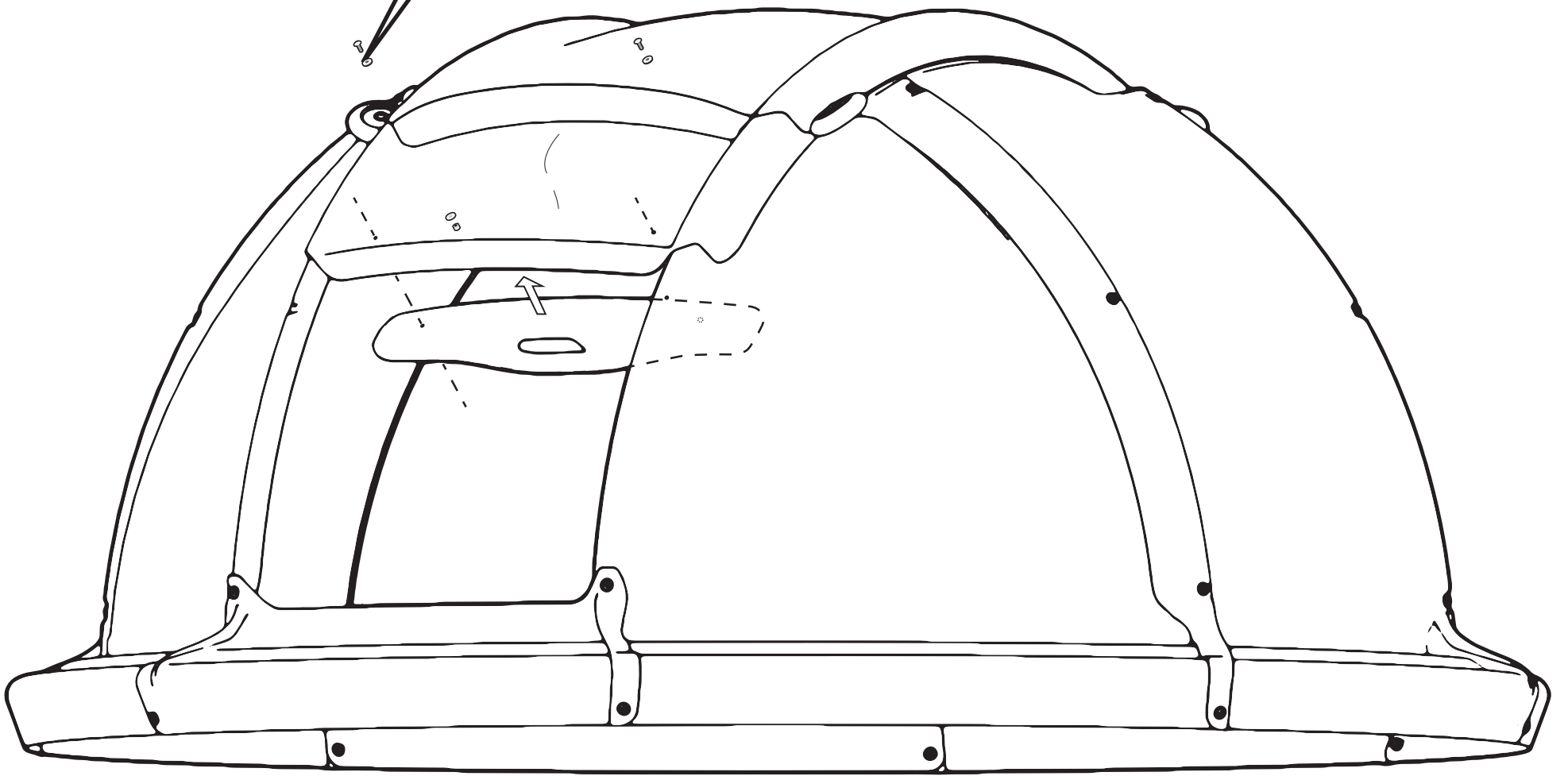
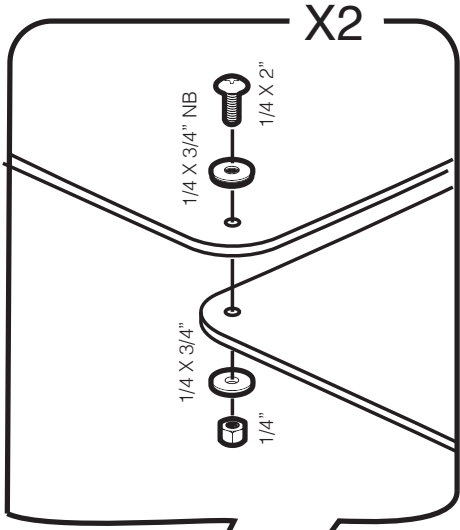

X1



X2



X2



X2



X2

NEXDOME 2.2M

Shutter Assembly

- 1** Place the lower shutter (the one with oval hole) over the top shutter panel as shown.

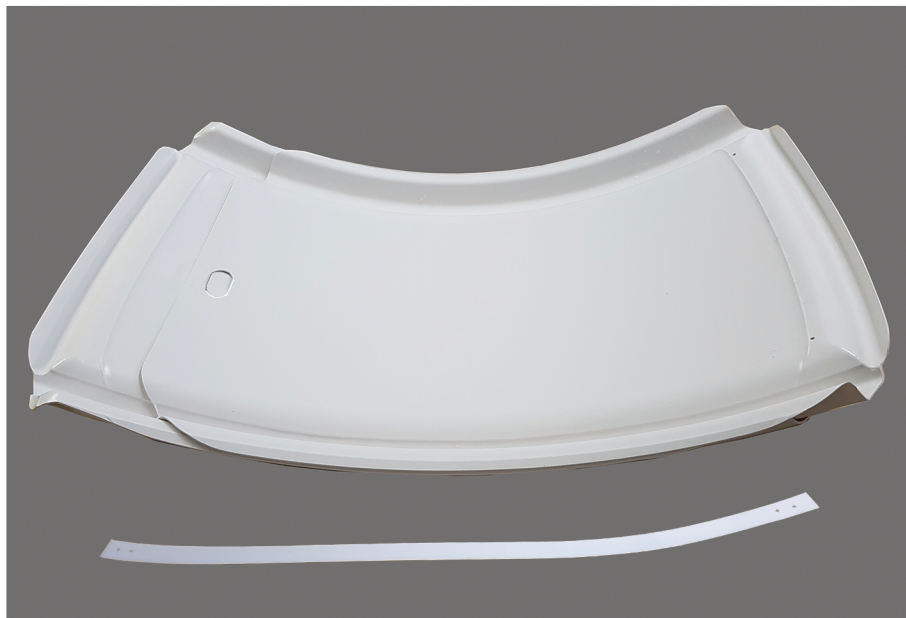

- 2** Attach one end of the provided strip on one end of the top shutter. Note that the flat end of the screw to be on inside.

Leave the strip between two shutter panels.

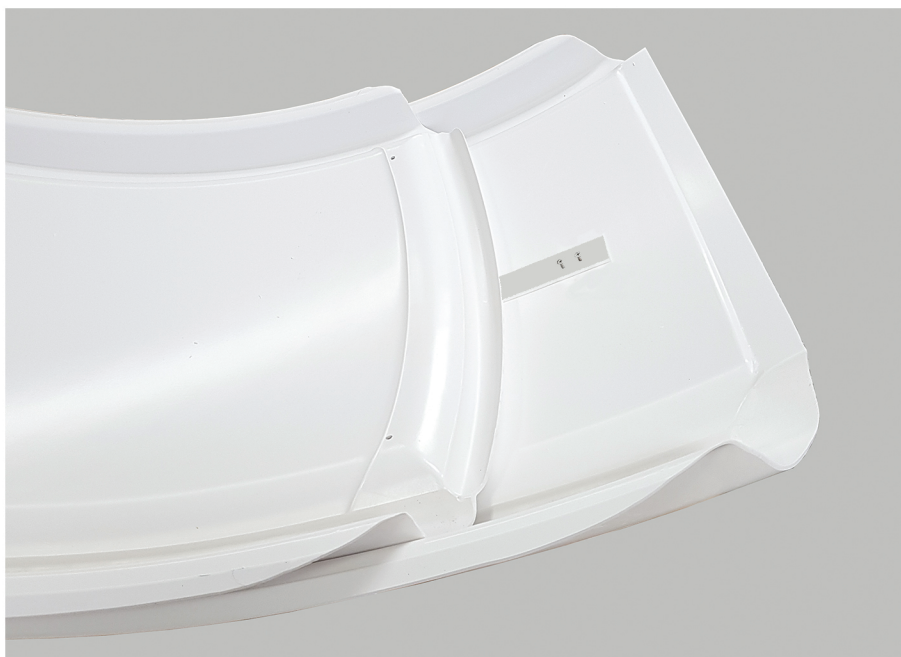

- 3** As shown, attach the other end of the strip to other end of top shutter THROUGH the oval hole of the lower shutter.





WWW.NEXDOME.COM
MADE IN CANADA